

LEVEL 3 ENCLOSURE OUTLINE DIMENSIONS W/ HOSPITAL GRADE SILENCER FOR SP-2000 THRU SP-3500

TOP VIEW

(GEN-SET HAS (6) DOORS, (3) SHOWN OPEN ARE TYPICAL FOR BOTH SIDES)

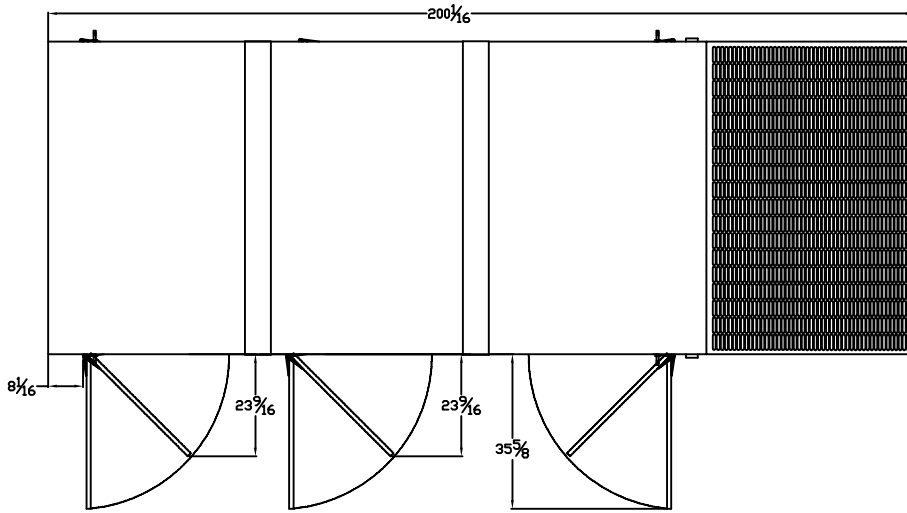

FRAME VIEW

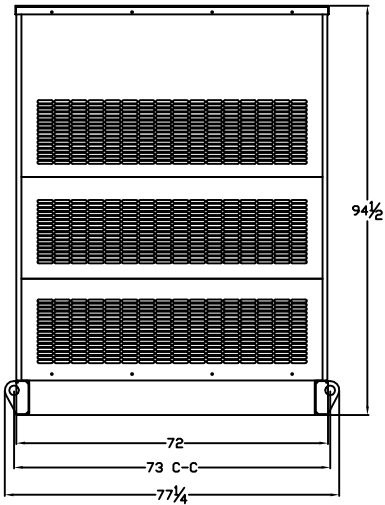
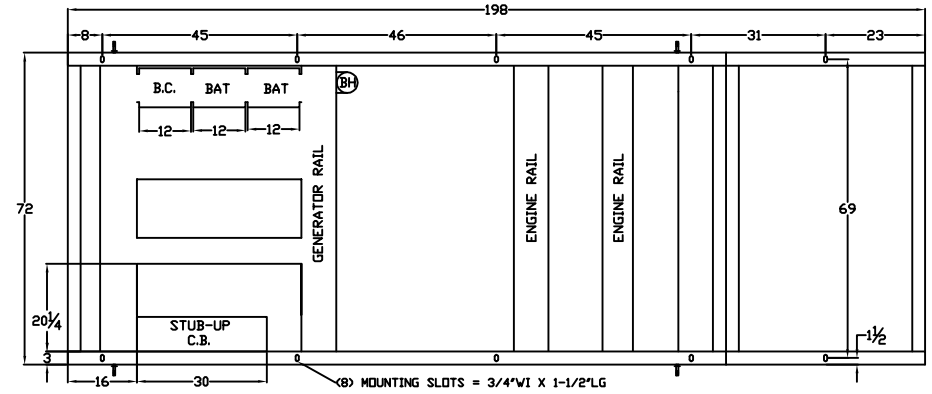

GENERATOR END VIEW

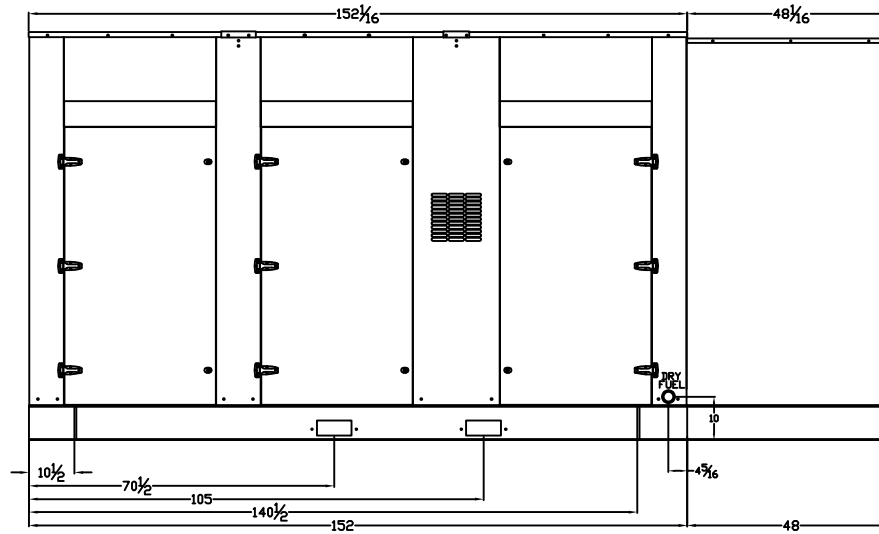

SIDE VIEW

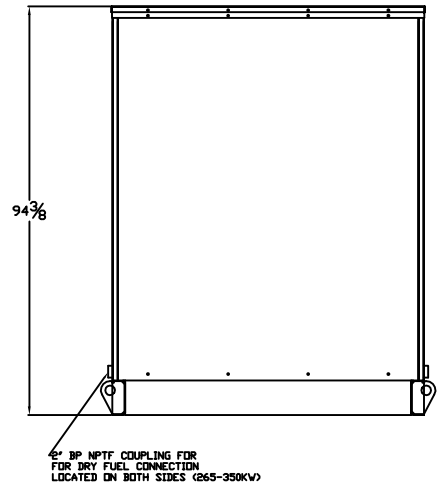

RADIATOR END VIEW